



Floating Canopy Systems

## MESH Sonic Element MT

(MESH Canopy MT)

Individual

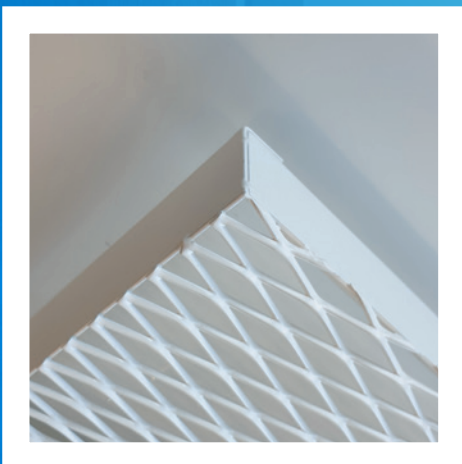











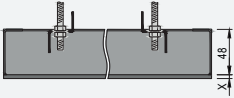

















- MESH Sonic Element MT provides a contemporary industrial look and feel. Breathe new life into your ceiling architecture – with a creative design, impressive simplicity and high performance.
- Flat visible side, without upturn, with welded stiffening profiles on all edges.
- Canopies delivered with stiffeners on the back and suspended by threaded rods or adjustable hanging wire kits.
- Standard single item solution.
- For the grouping option, the canopy can be delivered on request with additional bolt holes on the edges.
- Additional design options available as part of our **Vario Design** range.
- Ideal for open spaces and large rooms with flexible partitioning.



# MESH Sonic Element MT

Individual

<b>Edge details</b> 	<b>MESH Sonic Element MT</b>   <p>X = Mesh thickness</p>		
<b>System</b> 	Direct suspended (by threaded rod or wires)		Not included.
<b>Dimensions (mm)</b> 	Panel length: 800 - 1200 Panel width: (RB25) 800 - 1202 (in steps of 8mm) / (RB35, RB55) 800 - 1200		
<b>Material &amp; patterns</b> 	Galvanised steel RB25 = 1.0mm RB35 / RB55 = 1.5mm		
<b>Colours</b> 	 RAL 9010 <b>Other colours</b>  RAL 9005  RAL 9006  RAL 9007		
<b>Weight</b> 	<b>RB25</b> 6.4 - 11.5 kg/m <sup>2</sup>	<b>RB35</b> 6.9 - 12.6 kg/m <sup>2</sup>	<b>RB55</b> 6.6 - 12.0 kg/m <sup>2</sup>
<b>Fire reaction</b> 	Euroclass <b>A2-s1, d0</b> as per EN 13501-1		Values applicable for RAL 9010 solutions only.
<b>Humidity resistance</b> 	<b>95% RH</b>		
<b>Indoor air quality</b> 	 <p>A+</p>		
<b>Cleanability</b>	   		
<b>Sustainability</b>	 EN ISO 14001 ≈14%  EN ISO 14025  Silver*		*Value applicable for RAL 9010 solutions only.
<b>Design options</b>	 Dimensions  Colours  Patterns  Cut-Outs  Megapanel  Shape		

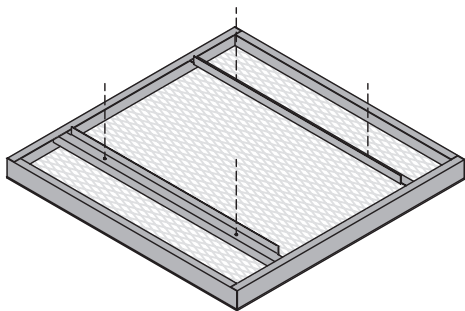

Threaded Rod M6

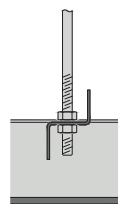

Hanging Wire Kit

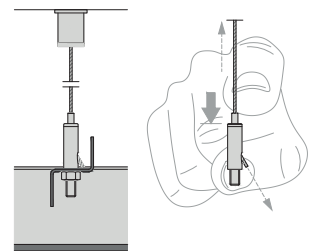

[Previous page] MESH Sonic Element MT (©Knauf Ceiling Solutions)

 Options with this icon are available from our **Vario Design** range. Some combinations of colours and/or perforations are not available for every product. Products may vary from country to country. Please contact your local sales representative. For further information and legal notice, please visit our website. [knaufceilingsolutions.com](http://knaufceilingsolutions.com)